

This document is intended as a reference guide for installing and using a BENDER VME420 AC/DC voltage and frequency monitor. This document includes installation, setup, and usage instructions. For complete details, including installation, setup, settings, and troubleshooting, refer to the VME420 user manual, document number TGH1399en. This document is intended as a supplement and not a replacement to the complete user manual.

Only qualified maintenance personnel shall operate or service this equipment. These instructions should not be viewed as sufficient for those who are not otherwise qualified to operate or service this equipment. This document is intended to provide accurate information only. No responsibility is assumed by BENDER for any consequences arising from use of this document.



## Installation

### Mounting

VME420 series devices may be DIN rail mounted, or screw mounted using the black clips located on the top and bottom of the device. Screw mounting requires an extra black clip (article number B98060008, sold separately). See dimensions below.

### Wiring - General

Refer to figure 1 for wiring the VME420. Use minimum AWG 24, maximum AWG 12 size wire. Refer to VME420 series user manual for complete technical details.

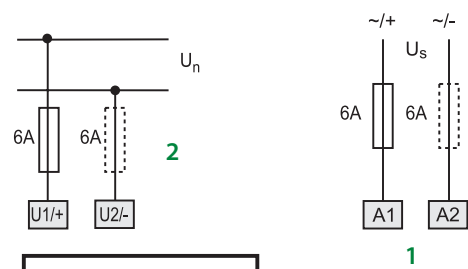
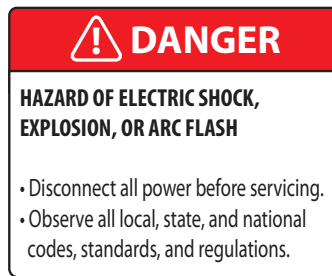

1. External supply voltage; 5A fuse required for internal device protection
2. System connections
3. Alarm relay K1: SPDT contact
4. Alarm relay K2: SPDT contact

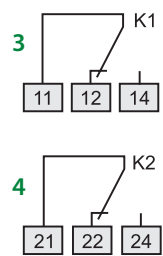

Figure 1 - VME420 wiring diagram

### Wiring - Contacts

Using a normally closed or normally open contact utilizes two factors: wiring out of the proper terminal, and setting the respective contact to normally energized or deenergized operation. Refer to the chart below for relay conditions. For changing the energized state of the contact, refer to "Figure 7 - Contact operation" on the reverse side of this document.

The factory default for the VME420 is normally energized operation for relay K2, and normally deenergized operation for relay K1.

Device Relay Conditions			
Relay Operation Setting	Device Alarm State	K1 STATE	K2 STATE
Normally deenergized mode (N/D) Non-failsafe mode "N/O" in device settings menu	Power ON, normal state (no alarms)	11-12 CLOSED 11-14 OPEN	21-22 CLOSED 21-24 OPEN
	Power OFF	11-12 CLOSED 11-14 OPEN	21-22 CLOSED 21-24 OPEN
Energized in the alarm state Relay will switch when the alarm is activated.	Power ON, alarm state	11-12 OPEN 11-14 CLOSED	21-22 OPEN 21-24 CLOSED
	Power OFF	11-12 CLOSED 11-14 OPEN	21-22 CLOSED 21-24 OPEN
Normally energized mode (N/E) Failsafe mode "N/C" in device settings menu	Power ON, normal state (no alarms)	11-12 OPEN 11-14 CLOSED	21-22 OPEN 21-24 CLOSED
	Power OFF	11-12 CLOSED 11-14 OPEN	21-22 CLOSED 21-24 OPEN
Energized in the normal state Relay will switch when the alarm is activated, or when supply voltage to the device is lost.	Power ON, alarm state	11-12 CLOSED 11-14 OPEN	21-22 CLOSED 21-24 OPEN

## Front Panel Display

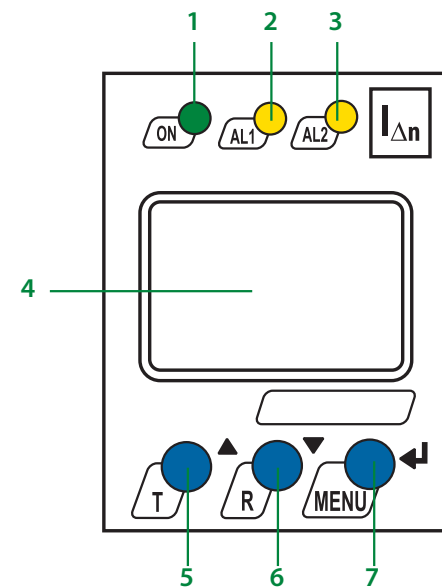
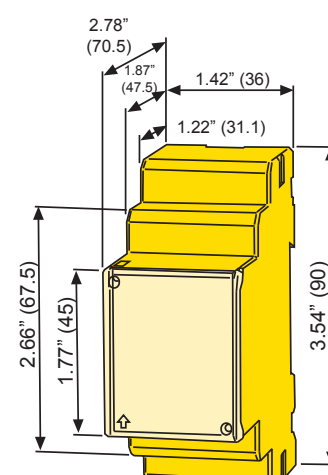

Figure 2 - VME420 front display

1. LED "ON" (green): Illuminates when power is applied to the device. Flashes when the CT connection alarm is active.
2. LED "AL1" (yellow): Illuminates when the prealarm is activated. Flashes when the CT connection alarm is active.
3. LED "AL2" (yellow): Illuminates when the main alarm is activated. Flashes when the CT connection alarm is active.
4. Backlit LCD display
5. TEST / UP button: Activates self-test / scrolls up inside main menu.
6. RESET / DOWN button: Resets device / scrolls down inside main menu.
7. MENU / ENTER button: Activates main menu / Confirms (momentary push) or goes back a step (held > 1.5 s) inside main menu.

## Dimensions

Dimensions in inches (mm).



## Menu Flow Chart for Common Settings

Figure 4 through figure 8 on the reverse side of this document contain flow charts for modifying commonly used features and settings in the VME420's main menu. Not all available features are listed in this document. For more information, consult the VME420 user manual.

## Menu Legend

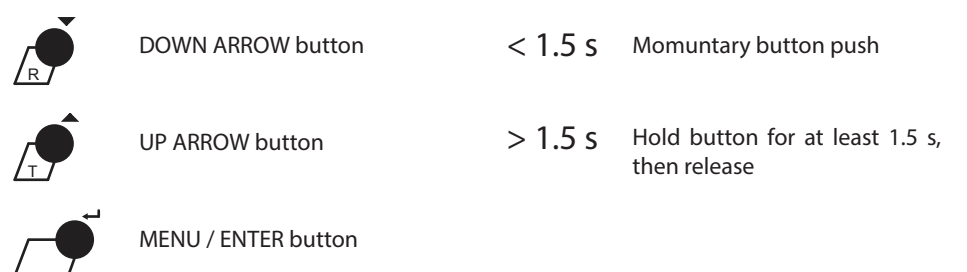

**Figure 4 - Setting alarm trip values**

The VME420 may be set to trip on undervoltage, overvoltage, overfrequency, and/or underfrequency. Any combination of these alarms may be set. Use the chart below for configuring trip values. Repeat or skip steps for the types of alarms you would like to use. Actual enabling and disabling of alarms may be configured using "Figure 8 - Relay Configuration."

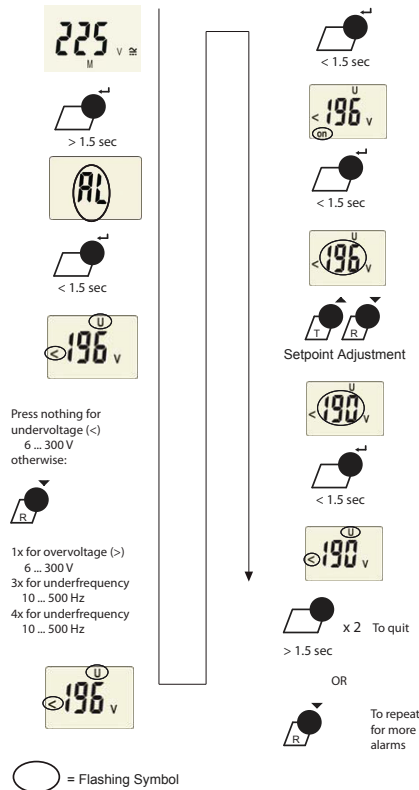

**Figure 5 - Changing Time Delays**

Four separate time delays are available:

- $t_{on1}$  - Response delay, prewarning
- $t_{on2}$  - Response delay, main alarm
- $t$  - Startup delay
- $t_{off}$  - Delay on release

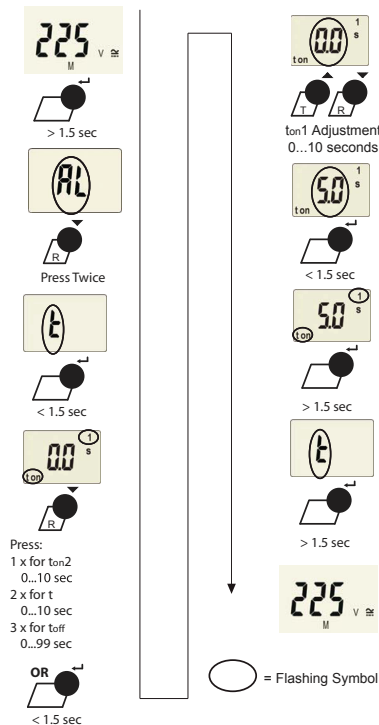

**Figure 6 - Latching behavior (fault memory)**

Changing this setting to "ON" will cause the VME420 to latch in the event of an alarm, and require a manual reset if the alarm clears. Changing this setting to "OFF" will cause the VME420 to automatically reset if the alarm clears.

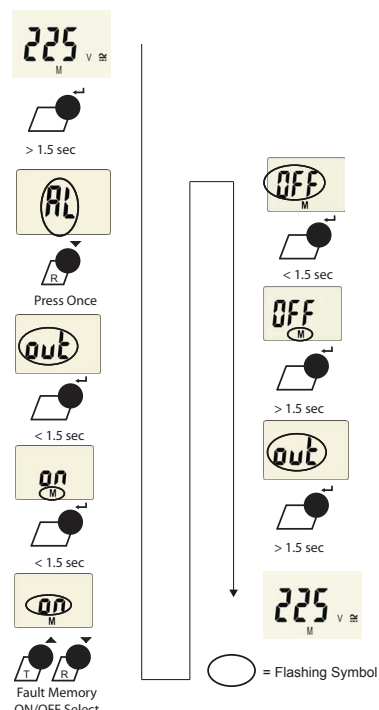

**Figure 7 - Contact operation**

Use this option to change the behavior of the contacts between normally deenergized (non-failsafe) mode and normally energized (failsafe) mode. The two SPDT contacts may be changed individually. Note that the VME420 labels normally deenergized operation as "N/O" and normally energized operation as "N/C"; utilizing a normally open or normally closed contact only depends on which contact output is wired.

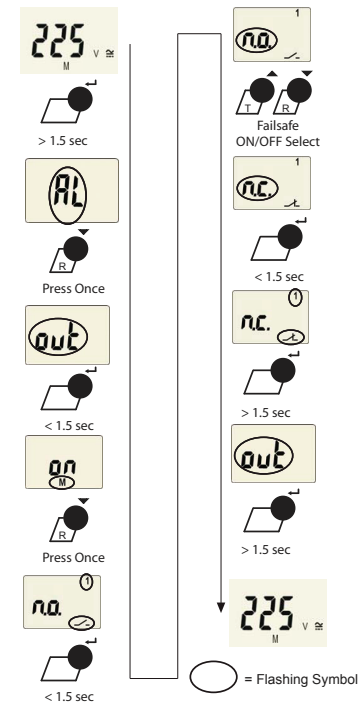

**Figure 8 - Relay Configuration**

The two relay contacts K1 and K2 may be configured to trip on any combination of alarm types. For example, K1 may be set to overvoltage and overfrequency, and K2 may be set to undervoltage and underfrequency. For each contact, each alarm type is turned on or off. The factory default is set to undervoltage only for K2, and overvoltage only for K1.

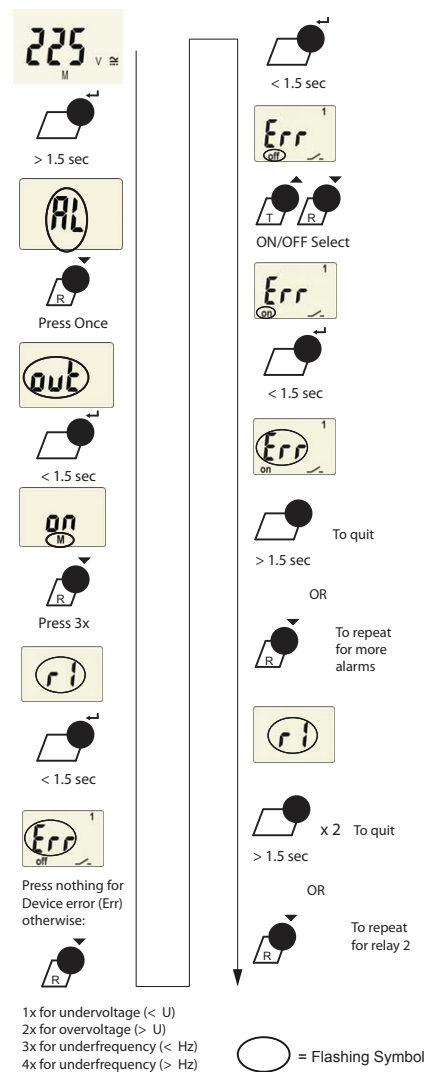

**Technical Data**

Refer to VME420 series user manual (document TGH1399en) or VME420 series datasheet (document NAE1032010) for detailed technical information.